

## Switching ON/OFF

Ein-/Ausschalten  
Mise en marche/arrêt



2 sec = OFF



## Power adjustment

Leistungseinstellung  
Ajustement de puissance



100-75-50%



## Status LED

LED Status  
Etat LED



Normal operation  
Normaler Betrieb  
Fonctionnement normal



Instrument locked  
Gerät gesperrt  
Instrument bloqué



Low battery  
Tiefer Batteriestand  
Batterie faible



Out of level  
Ausserhalb des  
Selbstnivellierbereichs  
Hors du niveau



## Adapter Setup

Adapter-Einrichtung  
Configuration de l'adaptateur

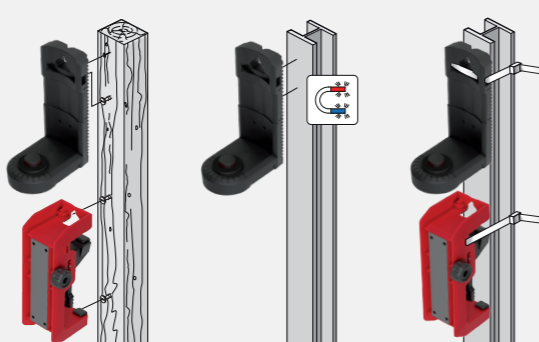

## Usable with UAL 130

Verwendbar mit UAL 130  
Utilisable avec UAL 130

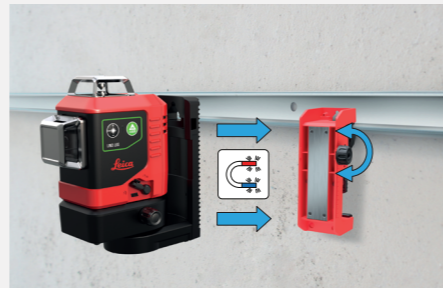

## Usable with Receiver

Verwendbar mit Empfänger  
Utilisable avec récepteur

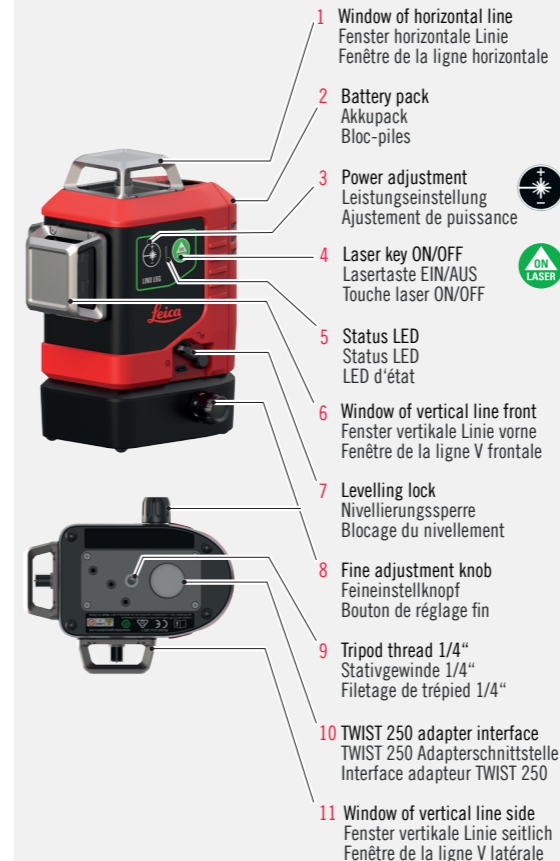
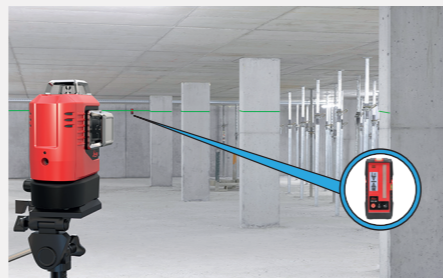

## Quick Start Schnellstartanleitung Guide de prise en main rapide

Leica Lino L6G



- when it has to be right

Leica  
Geosystems

Insert batteries/Li-Ion  
Batterien/Li-Ion einlegen  
Insérer des piles/Li-Ion



1x - Laser on/  
Vertical + horizontal mode  
1x - Laser an/ vert. + horizont. Modus  
1x - Laser on/mode vert. + horizont.

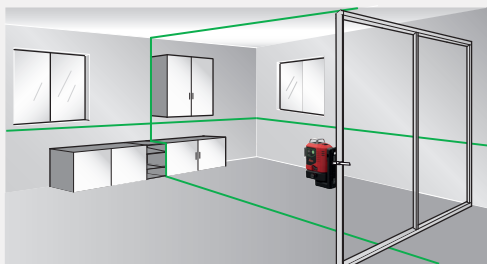

3x - Layout mode  
3x - Absteck Modus  
3x - Mode Implantation

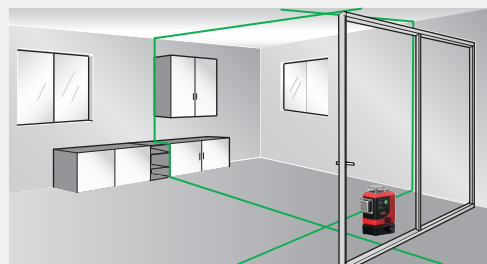

Horizontal mode  
Horizontaler Modus  
Mode horizontal

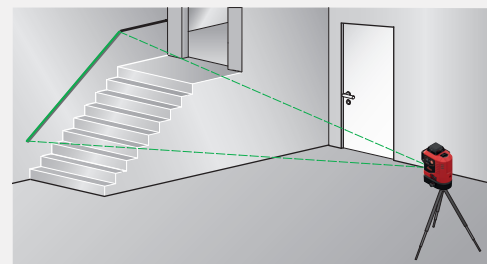

Vertical mode  
Vertikaler Modus  
Mode vertical



Transport



Charging Li-Ion battery  
Li-Ion Batterie aufladen  
Charger batterie Li-Ion



2x - All on mode  
2x - All-on Modus  
2x - Mode all on

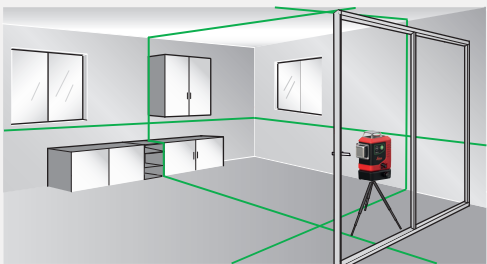

4x - Horizontal mode  
4x - Horizontaler Modus  
4x - Mode horizontal

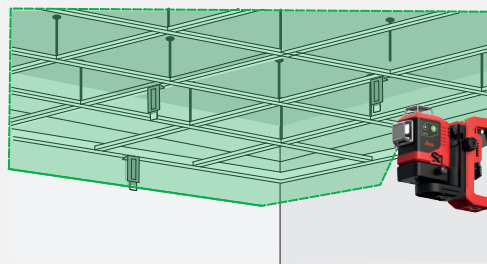

Self levelling/Levelling lock  
Selbstnivellierung/Nivellierungssperre  
Auto-nivellement/blocage du nivellement

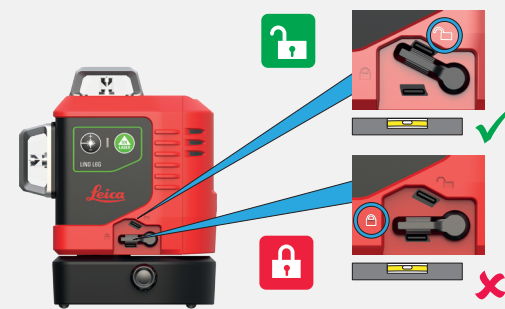

User Manual  
Bedienungsanleitung  
Manuel d'utilisation

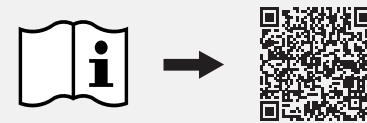

[www.leica-geosystems.com](http://www.leica-geosystems.com)

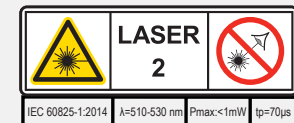

SAP- No. 913009